



Compact Low Friction Cylinder (Metal Seal Type)

Series **MQQ**

ø10, ø16, ø20, ø25, ø28

Series MQQ



Lateral Load Resisting Low Friction Cylinder
(Metal Seal Type)

Series **MQM**

ø6, ø10, ø16, ø20, ø25

Series MQM



MQQ - Compact low friction cylinder for uniform and low speeds
MQM - Lateral load resisting low friction cylinder for low to high speeds

Low Friction Cylinder (Metal Seal Type)

Series MQQ / $\varnothing 10, \varnothing 16, \varnothing 20, \varnothing 25, \varnothing 28$
Series MQM / $\varnothing 6, \varnothing 10, \varnothing 16, \varnothing 20, \varnothing 25$

Metal seal construction with low operating resistance allows actuation in speed

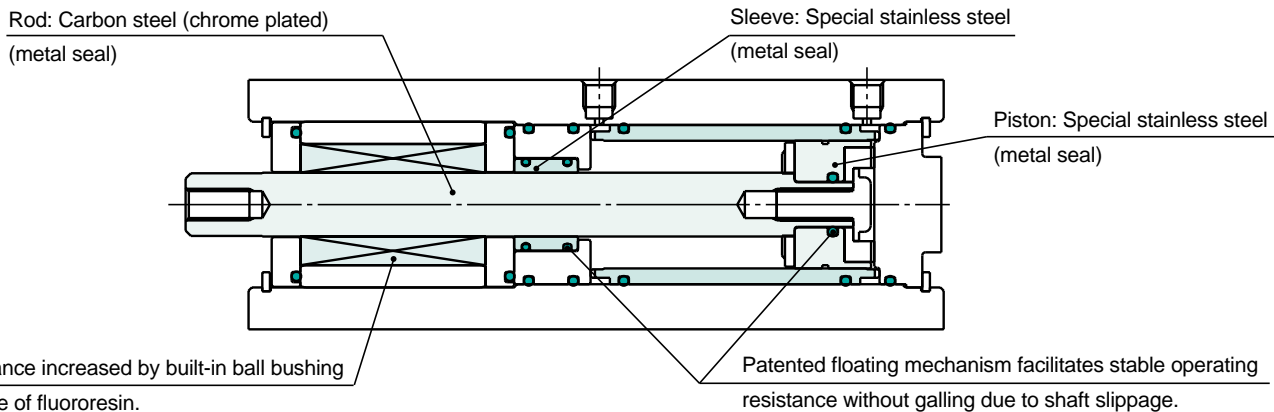

Low breakaway pressure

Minimal operating resistance allows low pressure actuation at 0.005MPa.

* Contact SMC regarding vacuum applications.

Long life

Long life of 10,000km or 100 million full cycles.

Low & uniform speed actuation

Smooth, uniform speed actuation ranges as low as 0.3mm/s.

Low friction

Low operating resistance and high stability allow force control as low as 0.05N.

(Based on cylinder Piston area x Pressure accuracy)

No increased operating resistance after periods of non-operation.

Series Variations

Series MQQ

Compact low friction cylinders designed for low pressure, low speed, uniform speed or low friction applications

Series	Bore size (mm)	Stroke (mm)								Operating pressure range (MPa)	Actuation speed (mm/s)
		10	20	30	40	50	60	75	100		
MQQT Standard type	10	●	●	●	●					0.005 to 0.5	0.3 to 300
	16	●	●	●	●	●					
	20	●	●	●	●	●	●				
MQQL Lateral load resisting type (built-in ball bushing)	25	●	●	●	●	●	●	●	●	0.005 to 0.7	0.5 to 500
	28	●	●	●	●	●	●	●	●		

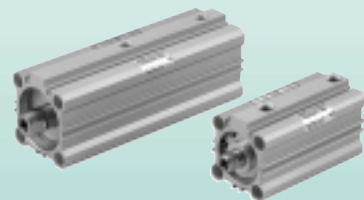

Series MQM

Lateral load resisting low friction cylinders for low pressure, low speed, uniform speed, low friction high pressure, high speed and high speed response (high frequency) actuation

Series	Bore size (mm)	Stroke (mm)						Operating pressure range (MPa)	Actuation speed (mm/s)
		15	30	45	60	75	100		
MQML Standard type	6 (standard only)	●	●	●	●			$\varnothing 6$: 0.02 to 0.7 $\varnothing 10$ to $\varnothing 25$: 0.005 to 0.7	0.5 to 1000
	10	●	●	●	●	●			
	16	●	●	●	●	●	●		
MQML□□H High speed/frequency	20	●	●	●	●	●	●	0.01 to 0.7	5 to 3000
	25	●	●	●	●	●	●		



High speed, high frequency actuation

H type achieves speeds up to 3,000mm/s (without fixed orifice), and continuous actuation up to 50 cpm. (MQML□□H)

Application examples

Pressure control with fine pressure variations

Applicable models: **MQQT/MQML**

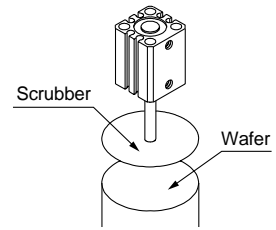

Polishing of wafers

Lateral load resistance

Lateral load resistance is increased by a built-in ball bushing. (MQQL/MQML)

Cutting of glass and lenses, requiring constant force

Applicable models: **MQQL/MQML**

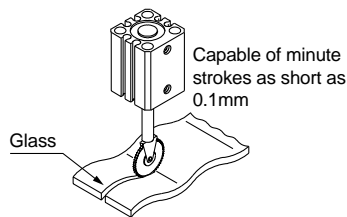

Cutting of wavy surfaces

Tension control responding to very low pressure and minute pressure variations

Applicable models: **MQQL/MQML**

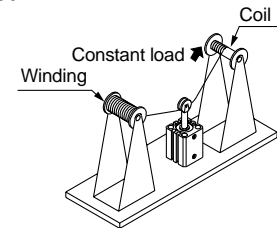

Coil winding

Transfer of precision components, etc., that require low or uniform speed actuation

Applicable models: **MQQT/MQML**

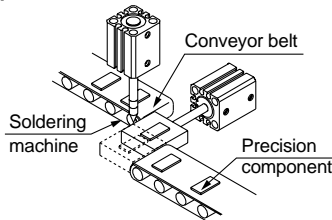

Transfer of precision components

Elimination of non-conforming articles requiring high speed actuation

Applicable models: **MQML/MQML□□H**

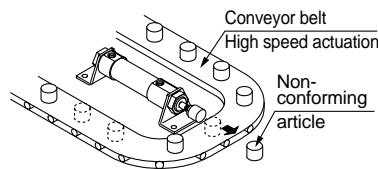

Elimination of non-conforming articles

Punching operations requiring high frequency actuation

Applicable models: **MQML/MQML□□H**

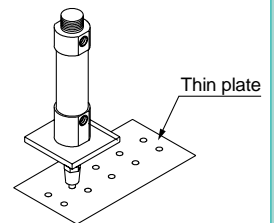

Punching

Recommended circuit examples

Example 1) Uniform & low speed actuation (no control of cylinder output)

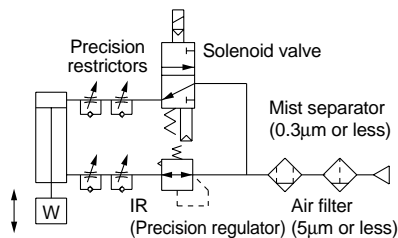

* When using a solenoid valve, use a metal seal type (series VQ, VQZ, SQ, etc.).

Example 2) Low speed with output control

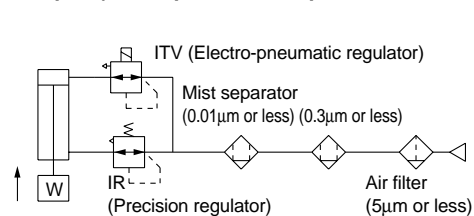

* When performing control of cylinder output, do not create a restriction circuit using a speed controller, etc. Pressure inside the cylinder will drop and control will become impossible. Always control actuation by means of pressure control.

Example 3) High speed & high frequency actuation

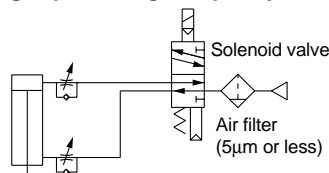

* When using a solenoid valve, use a metal seal type (series VQ, VQZ, SQ, etc.).

Applications based on low friction specification

- 1) Operating resistance will vary with an offset load. Be sure to properly align the rod axis with the load and direction of movement when connecting. When an offset load is expected, provide a suitable mechanism such as a floating joint.
- 2) Use clean air (atmospheric pressure dew point temperature -10°C or less). Use of a series AM mist separator (filtration rating of 0.3µm or less), or series AM + AMD (filtration rating of 0.01µm or less) is recommended.

Metal Seal

Compact Low Friction Cylinder

Series **MQQ**

∅10, ∅16, ∅20, ∅25, ∅28

How to Order

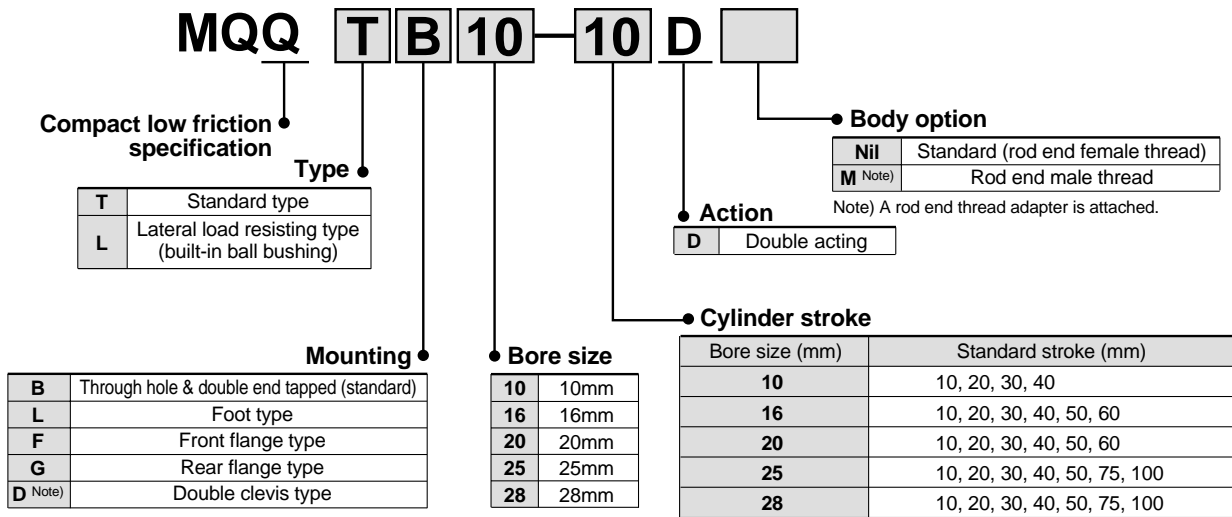

Note) Available only for MQQL□.

* Mounting brackets are included when shipped, but are not assembled.

* Strokes are available in 1mm increments by installing spacers in standard stroke cylinders.

* Series MQQ is not auto switch capable.

Mounting Bracket Part Numbers

Bore size (mm)	Foot <small>Note 1)</small>	Flange	Double clevis	Rod end thread adapter (with nut)
10	CQS-L016	CQS-F016	CQS-D016	MQ10-M
16	CQS-L020	CQS-F020	CQS-D020	MQ16-M
20	CQS-L025	CQS-F025	CQS-D025	MQ20-M
25	CQ-L032	CQ-F032	CQ-D032	MQ25-M
28	CQ-L040	CQ-F040	CQ-D040	MQ28-M

Note 1) When ordering foot brackets, order 2 pcs. for each cylinder.

Note 2) The following parts are included with the respective brackets.

Foot, Flange Body mounting bolts
 Double clevis Clevis pin, C type snap ring for shaft, Body mounting bolts

Specifications/Standard Type: MQQT



Bore size (mm)		10	16	20	25	28
Seal construction		Metal seal				
Action		Double acting single rod				
Fluid		Air				
Proof pressure		1.05MPa				
Maximum operating pressure		0.5MPa				
Minimum operating pressure <small>Note 1)</small>		0.005MPa				
Ambient and fluid temperature		-10 to 80°C				
Cushion		Rubber bumper (standard)				
Lubrication <small>Note 2)</small>		Not required (non-lube)				
Rod end thread		Female thread				
Rod end thread tolerance		JIS class 2				
Stroke length tolerance		+1.0 0				
Piston speed <small>Note 3)</small>		0.3 to 300mm/s (Refer to page 23.)				
Total allowable leakage	Supply pressure 0.1MPa	150cm ³ /min or less	200cm ³ /min or less	300cm ³ /min or less	300cm ³ /min or less	300cm ³ /min or less
	Supply pressure 0.3MPa	800cm ³ /min or less	1000cm ³ /min or less	1200cm ³ /min or less	1200cm ³ /min or less	1200cm ³ /min or less
	Supply pressure 0.5MPa	1500cm ³ /min or less	2000cm ³ /min or less	2000cm ³ /min or less	3000cm ³ /min or less	3000cm ³ /min or less

Note 1) Use clean, dry air with no freezing.

Note 2) Refer to precautions on page 21 regarding lubrication.

Note 3) Control low speed actuation with differential pressure and a speed controller, etc. (Refer to recommended circuit examples for further details.)

Symbol

Double acting: Single rod

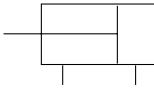

Specifications/Lateral Load Resisting Type: MQQL

Bore size (mm)		10	16	20	25	28
Seal construction		Metal seal				
Action		Double acting single rod				
Fluid		Air				
Proof pressure		1.05MPa				
Maximum operating pressure		0.7MPa				
Minimum operating pressure <small>Note 1)</small>		0.005MPa				
Ambient and fluid temperature		-10 to 80°C				
Cushion		Rubber bumper (standard)				
Lubrication <small>Note 2)</small>		Not required (non-lube)				
Rod end thread		Female thread				
Rod end thread tolerance		JIS class 2				
Stroke length tolerance		+1.0 0				
Piston speed <small>Note 3)</small>		0.5 to 500mm/s (Refer to page 23.)				
Total allowable leakage	Supply pressure 0.1MPa	150cm ³ /min or less	200cm ³ /min or less	300cm ³ /min or less	300cm ³ /min or less	300cm ³ /min or less
	Supply pressure 0.3MPa	800cm ³ /min or less	1000cm ³ /min or less	1200cm ³ /min or less	1200cm ³ /min or less	1200cm ³ /min or less
	Supply pressure 0.5MPa	1500cm ³ /min or less	2000cm ³ /min or less	2000cm ³ /min or less	3000cm ³ /min or less	3000cm ³ /min or less

Note 1) Use clean, dry air with no freezing.

Note 2) Refer to precautions on page 21 regarding lubrication.

Note 3) Control low speed actuation with differential pressure and a speed controller, etc. (Refer to recommended circuit examples for further details.)

Weights/Standard Type: MQQT

Unit: g

Bore size (mm)	Cylinder stroke (mm)							
	10	20	30	40	50	60	75	100
10	94	118	142	166	—	—	—	—
16	166	206	246	286	326	366	—	—
20	228	290	352	414	476	538	—	—
25	395	487	579	671	763	—	993	1223
28	661	799	937	1075	1213	—	1558	1903

Weights/Lateral Load Resisting Type: MQQL (Built-in Ball Bushing)

Unit: g

Bore size (mm)	Cylinder stroke (mm)							
	10	20	30	40	50	60	75	100
10	148	172	196	220	—	—	—	—
16	284	324	364	404	444	484	—	—
20	383	445	507	569	631	693	—	—
25	552	644	736	828	920	—	1150	1380
28	965	1103	1241	1379	1517	—	1862	2207

Theoretical Output

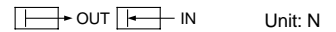

Unit: N

Bore size (mm)	Rod size (mm)	Direction	Piston area (mm ²)	Operating pressure (MPa)						
				0.1	0.2	0.3	0.4	0.5	0.6	0.7
10	6	IN	50.3	5.0	10.1	15.1	20.1	25.2	30.2	35.2
		OUT	78.5	7.9	15.7	23.6	31.4	39.3	47.1	55.0
16	8	IN	145.8	14.9	29.2	43.7	58.3	72.9	87.5	102.1
		OUT	196.1	19.6	39.2	58.9	78.4	98.1	117.7	137.3
20	10	IN	235.6	23.6	47.1	70.7	94.2	117.8	141.4	164.9
		OUT	314.2	31.4	62.8	94.3	125.7	157.1	188.5	219.9
25	12	IN	377.8	37.8	75.6	113.3	151.1	188.9	226.7	262.5
		OUT	490.9	49.1	98.2	147.3	196.4	245.5	294.5	343.6
28	16	IN	423.5	42.4	84.7	127.1	169.4	211.8	254.1	296.5
		OUT	624.6	62.5	124.9	187.4	249.8	312.3	374.8	437.2

Series MQQ

Construction

Standard type/MQQT

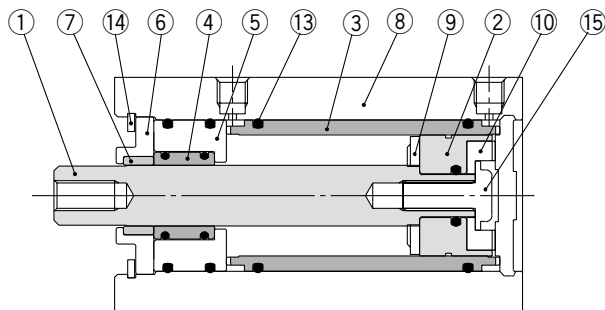

Lateral load resisting type/MQQL (built-in ball bushing)

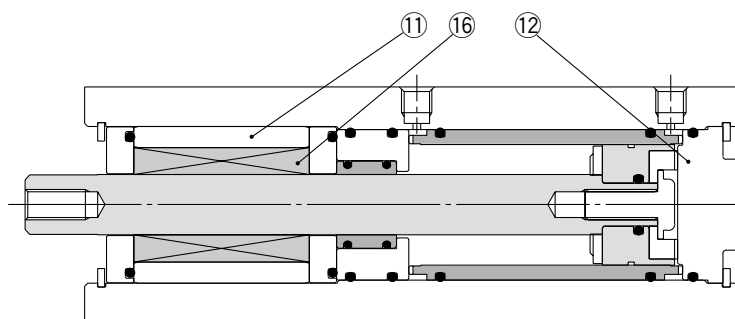

Parts list

No.	Description	Material	Note
1	Rod	Carbon steel	Hard chrome plated
2	Piston	Special stainless steel	
3	Liner	Special stainless steel	
4	Sleeve	Special stainless steel	
5	Sleeve retainer	Aluminum alloy	
6	Plate	Aluminum alloy	Hard anodized
7	Guide	Fluororesin	
8	Cylinder tube	Aluminum alloy	Hard anodized
9	Bumper A	Polyurethane	
10	Bumper B	Polyurethane	
11	Bushing	Aluminum alloy	
12	Bottom plate	Aluminum alloy	Hard anodized
13	O-ring	NBR	
14	Retaining ring	Carbon tool steel	Nickel plated
15	Bolt	Carbon tool steel	Nickel plated
16	Ball bushing		

Mounting

Mounting bolts

a) A type mounting (when using the mounting plate threads)

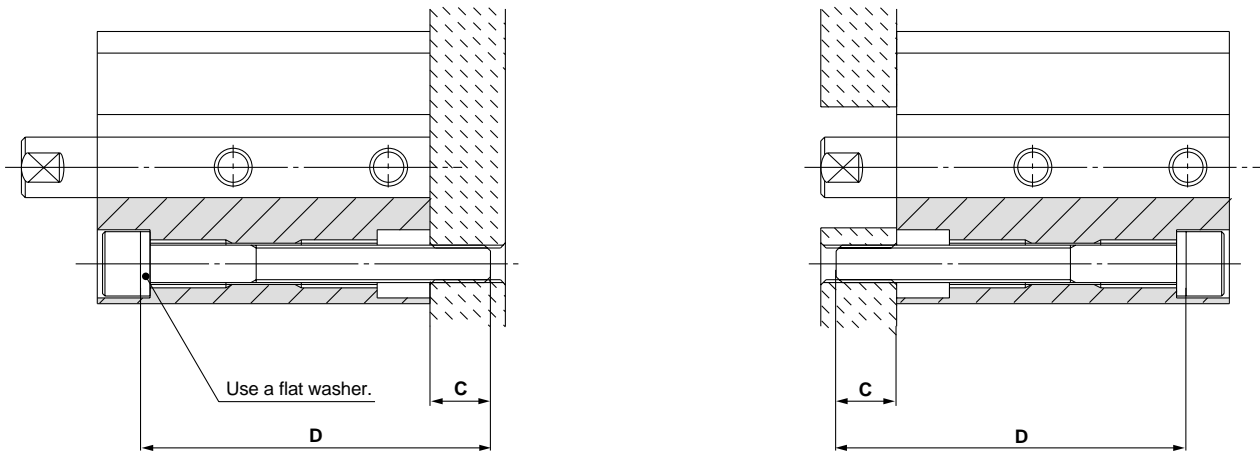

Note) Be sure to use a flat washer for the A type mounting.

b) B type mounting (when using the cylinder tube threads)

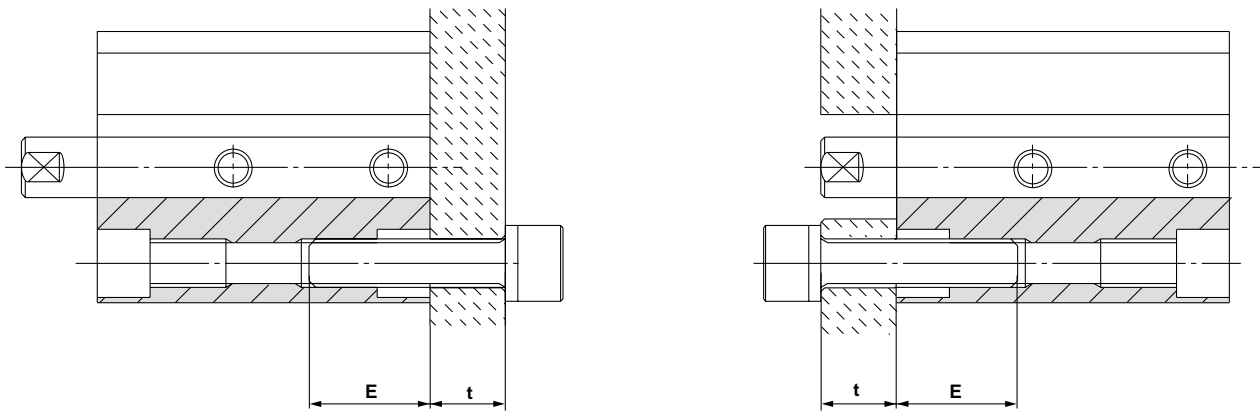

Compatible mounting bolt dimensions

Model	A type mounting			B type mounting		
	Mounting bolt size	C (mm)	D: Bolt length (mm)	Mounting bolt size	E (mm)	
Standard type MQQT	MQQTB10-□D	M3 x 0.5	7	35 + Stroke	M4 x 0.7	8 to 11
	MQQTB16-□D	M5 x 0.8	7	35 + Stroke	M6 X 1	13 to 17
	MQQTB20-□D		8.5	40 + Stroke		
	MQQTB25-□D		9	45 + Stroke		
	MQQTB28-□D		7.5	50 + Stroke		
Lateral load resisting type MQQL (built-in ball bushing)	MQQLB10-□D	M3 x 0.5	7	65 + Stroke	M4 x 0.7	8 to 11
	MQQLB16-□D	M5 x 0.8	5.5	70 + Stroke	M6 x 1	13 to 17
	MQQLB20-□D		8	80 + Stroke		
	MQQLB25-□D		6.5	85 + Stroke		
	MQQLB28-□D		7	105 + Stroke		

□: Stroke

Series MQQ

Dimensions

Standard type (through hole and double end tapped)/MQQT B

ø10, ø16, ø20

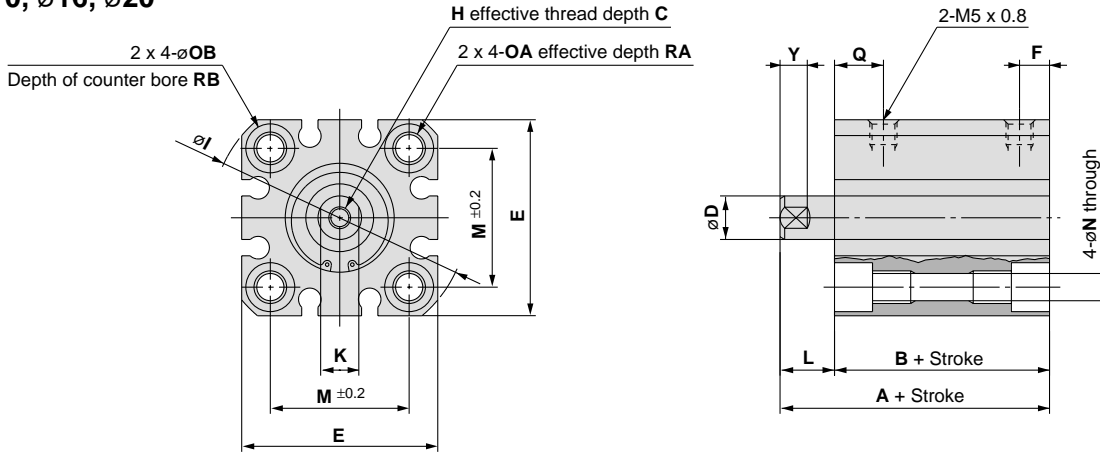

ø25, ø28

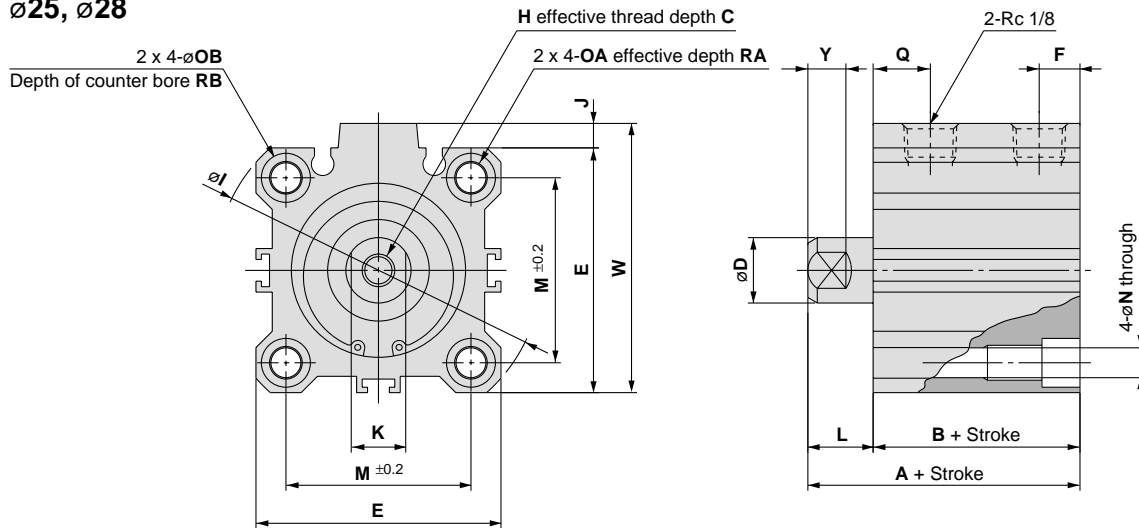

Bore size (mm)	Stroke range (mm)	A	B	C	D	E	F	H	I	J	K	L	M	N	OA	OB	Q	RA	RB	W	Y
10	10 to 40	39.5	31.5	6	6	29	5.5	M3 x 0.5	38	—	5	8	20	3.5	M4 x 0.7	6.5	14.5	7	4	—	5
16	10 to 60	44	34	8	8	36	5.5	M4 x 0.7	47	—	7	10	25.5	5.4	M6 x 1.0	9	18	10	7	—	5
20	10 to 60	47.5	37.5	10	10	40	5.5	M5 x 0.8	52	—	8	10	28	5.4	M6 x 1.0	9	19.5	10	7	—	6
25	10 to 50, 75, 100	54	42	12	12	45	8.5	M6 x 1.0	60	4.5	10	12	34	5.5	M6 x 1.0	9	23	10	7	49.5	7
28	10 to 50, 75, 100	60.5	48.5	13	16	52	8.5	M8 x 1.25	69	5	14	12	40	5.5	M6 x 1.0	9	26	10	7	57	10

With rod end male thread/MQQ□-□DM

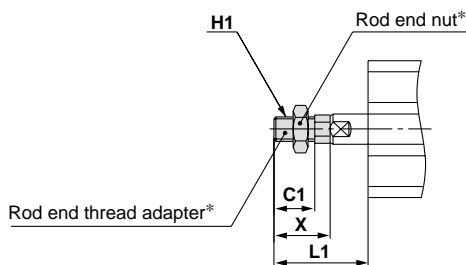

Bore size (mm)	L1	C1	H1	X
10	23.5	10.5	M5 x 0.8	15.5
16	26.5	11.5	M6 x 1.0	16.5
20	28.5	13.5	M8 x 1.25	18.5
25	34.5	16.5	M10 x 1.25	22.5
28	40.5	22.5	M14 x 1.5	28.5

* Refer to page 9 for details regarding the rod end thread adapter and rod end nut.

Foot type/MQQTL
ø10, ø16, ø20

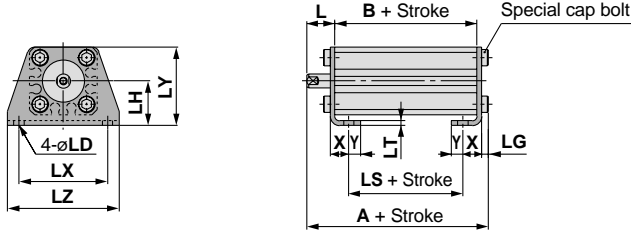

ø25, ø28

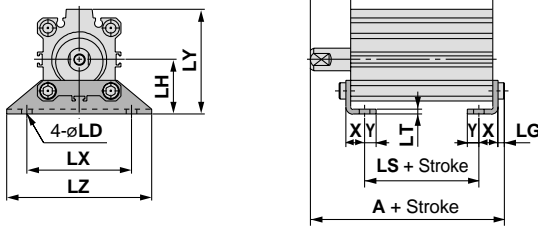

Bore size (mm)	Stroke range (mm)	A	B	L	LD	LG	LH
10	10 to 40	44.3	31.5	8	4.5	2.8	19
16	10 to 60	51.2	34	10	6.6	4	24
20	10 to 60	54.7	37.5	10	6.6	4	26
25	10 to 50,75,100	61.2	42	12	6.6	4	30
28	10 to 50,75,100	67.7	48.5	12	6.6	4	33

Bore size (mm)	LS	LT	LX	LY	LZ	X	Y
10	19.5	2	38	33.5	48	8	5
16	22	3.2	48	42	62	9.2	5.8
20	22.5	3.2	52	46	66	10.7	5.8
25	26	3.2	57	57	71	11.2	5.8
28	32.5	3.2	64	64	78	11.2	7

Front flange type/MQQTF
ø10, ø16, ø20

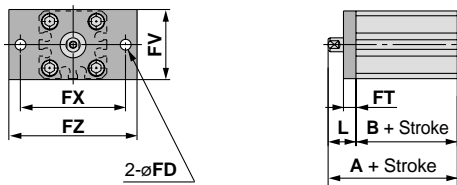

ø25, ø28

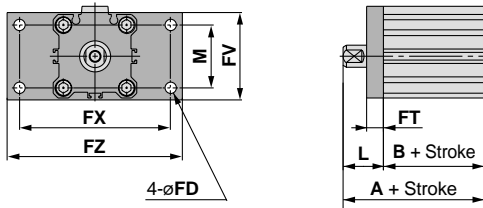

Bore size (mm)	Stroke range (mm)	A	B	FD	FT	FV	FX
10	10 to 40	49.5	31.5	4.5	5.5	30	45
16	10 to 60	54	34	6.6	8	39	48
20	10 to 60	57.5	37.5	6.6	8	42	52
25	10 to 50,75,100	64	42	5.5	8	48	56
28	10 to 50,75,100	70.5	48.5	5.5	8	54	62

Bore size (mm)	FZ	L	M
10	55	18	—
16	60	20	—
20	64	20	—
25	65	22	34
28	72	22	40

Rear flange type/MQQTG
ø10, ø16, ø20

ø25, ø28

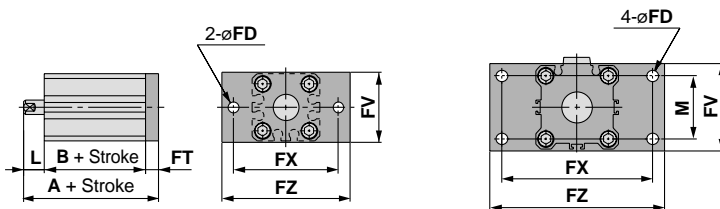

Bore size (mm)	Stroke range (mm)	A	L
10	10 to 40	45	8
16	10 to 60	52	10
20	10 to 60	55.5	10
25	10 to 50,75,100	62	12
28	10 to 50,75,100	68.5	12

(Dimensions other than A and L are the same as the front flange type.)

Series MQQ

Dimensions

Lateral load resisting type (through hole and double end tapped)/MQQLB $\varnothing 10, \varnothing 16, \varnothing 20$

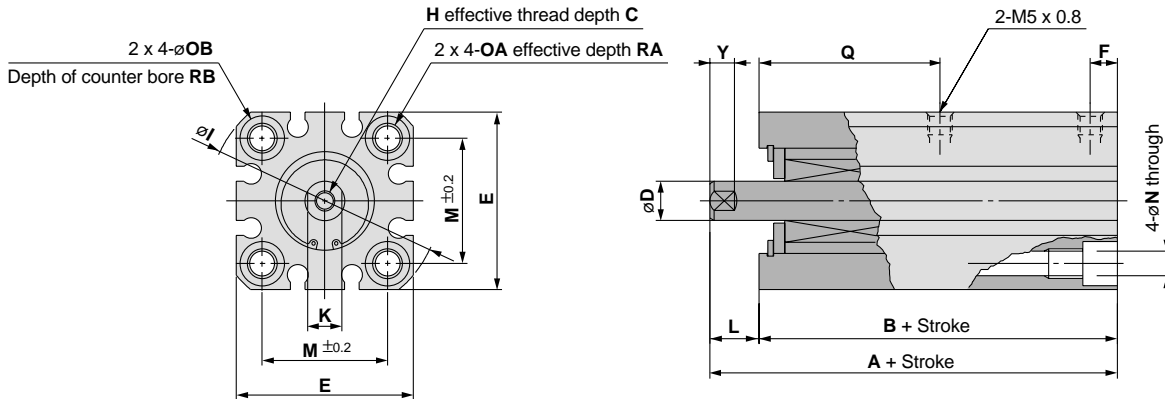

$\varnothing 25, \varnothing 28$

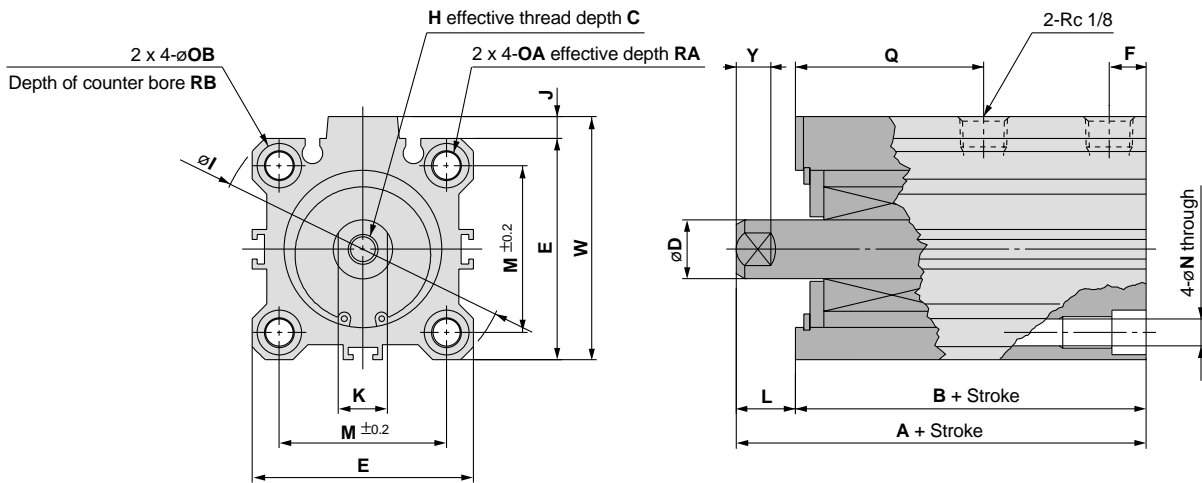

Bore size (mm)	Stroke range (mm)	A	B	C	D	E	F	H	I	J	K	L	M	N	OA	OB	Q	RA	RB	W	Y
10	10 to 40	69.5	61.5	6	6	29	9	M3 x 0.5	38	—	5	8	20	3.5	M4 x 0.7	6.5	39.5	7	4	—	5
16	10 to 60	80.5	70.5	8	8	36	11.5	M4 x 0.7	47	—	7	10	25.5	5.4	M6 x 1.0	9	48.5	10	7	—	5
20	10 to 60	89	79	10	10	40	12	M5 x 0.8	52	—	8	10	28	5.4	M6 x 1.0	9	55	10	7	—	6
25	10 to 50, 75, 100	96.5	84.5	12	12	45	13.5	M6 x 1.0	60	4.5	10	12	34	5.5	M6 x 1.0	9	58	10	7	49.5	7
28	10 to 50, 75, 100	116	104	13	16	52	17.5	M8 x 1.25	69	5	14	12	40	5.5	M6 x 1.0	9	71	10	7	57	10

With rod end male thread/MQQ□-□DM

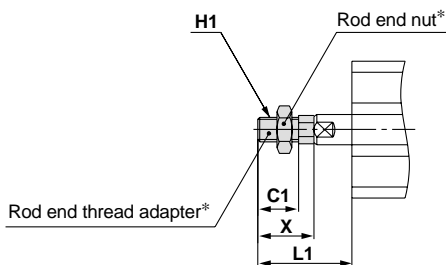

Bore size (mm)	L1	C1	H1	X
10	23.5	10.5	M5 x 0.8	15.5
16	26.5	11.5	M6 x 1.0	16.5
20	28.5	13.5	M8 x 1.25	18.5
25	34.5	16.5	M10 x 1.25	22.5
28	40.5	22.5	M14 x 1.5	28.5

* Refer to page 9 for details regarding the rod end thread adapter and rod end nut.

Foot type/MQQLL
ø10, ø16, ø20

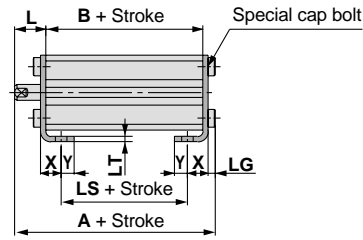
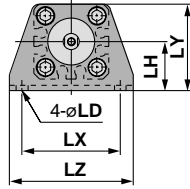

ø25, ø28

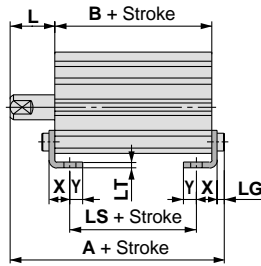
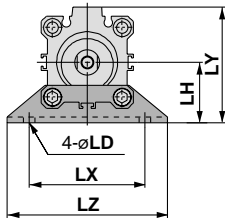

Bore size (mm)	Stroke range (mm)	A	B	L	LD	LG	LH
10	10 to 40	74.3	61.5	8	4.5	2.8	19
16	10 to 60	87.7	70.5	10	6.6	4	24
20	10 to 60	96.2	79	10	6.6	4	26
25	10 to 50, 75, 100	103.7	84.5	12	6.6	4	30
28	10 to 50, 75, 100	123.2	104	12	6.6	4	33

Bore size (mm)	LS	LT	LX	LY	LZ	X	Y
10	49.5	2	38	33.5	48	8	5
16	58.5	3.2	48	42	62	9.2	5.8
20	64	3.2	52	46	66	10.7	5.8
25	68.5	3.2	57	57	71	11.2	5.8
28	88	3.2	64	64	78	11.2	7

Front flange type/MQQLF
ø10, ø16, ø20

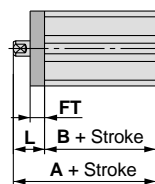
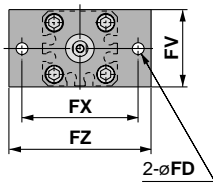

ø25, ø28

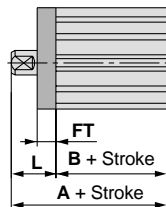
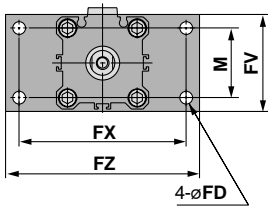

Bore size (mm)	Stroke range (mm)	A	B	FD	FT	FV	FX
10	10 to 40	79.5	61.5	4.5	5.5	30	45
16	10 to 60	90.5	70.5	6.6	8	39	48
20	10 to 60	99	79	6.6	8	42	52
25	10 to 50, 75, 100	106.5	84.5	5.5	8	48	56
28	10 to 50, 75, 100	126	104	5.5	8	54	62

Bore size (mm)	FZ	L	M
10	55	18	—
16	60	20	—
20	64	20	—
25	65	22	34
28	72	22	40

Rear flange type/MQQLG
ø10, ø16, ø20

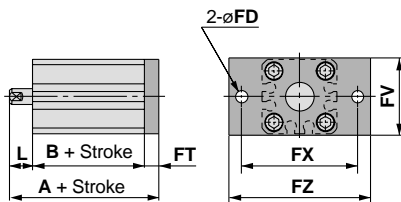

ø25, ø28

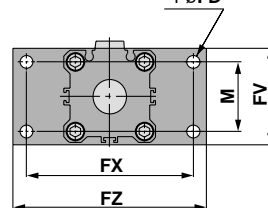

Bore size (mm)	Stroke range (mm)	A	L
10	10 to 40	75	8
16	10 to 60	88.5	10
20	10 to 60	97	10
25	10 to 50, 75, 100	104.5	12
28	10 to 50, 75, 100	124	12

(Dimensions other than A and L are the same as the front flange type.)

Double clevis type/MQQLD

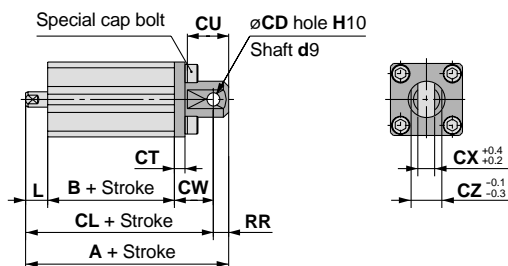

Bore size (mm)	Stroke range (mm)	A	B	CD	CL	CT	CU
10	10 to 40	90.5	61.5	5	84.5	4	10
16	10 to 60	107.5	70.5	8	98.5	5	12
20	10 to 60	119	79	10	109	5	14
25	10 to 50, 75, 100	126.5	84.5	10	116.5	5	14
28	10 to 50, 75, 100	148	104	10	138	6	14

Bore size (mm)	CW	CX	CZ	L	RR
10	15	6.5	12	8	6
16	18	8	16	10	9
20	20	10	20	10	10
25	20	18	36	12	10
28	22	18	36	12	10

Series MQQ

Accessory Dimensions

Rod end thread adapter

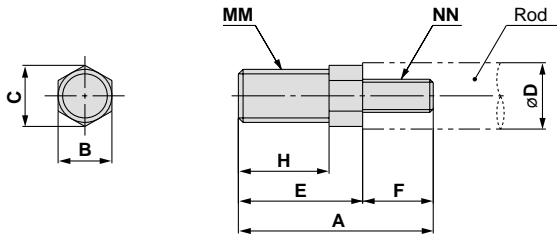

Part no.	Applicable bore size (mm)	A	B	C	D	E	F
MQ10-M	10	20.5	8	9.2	6	15.5	5
MQ16-M	16	22.5	8	9.2	8	16.5	6
MQ20-M	20	24.5	8	9.2	10	18.5	6
MQ25-M	25	33.5	10	11.5	12	22.5	11
MQ28-M	28	40.5	14	16	16	28.5	12

Part no.	Applicable bore size (mm)	H	MM	NN
MQ10-M	10	10.5	M5 x 0.8	M3 x 0.5
MQ16-M	16	11.5	M6 x 1.0	M4 x 0.7
MQ20-M	20	13.5	M8 x 1.25	M5 x 0.8
MQ25-M	25	16.5	M10 x 1.25	M6 x 1.0
MQ28-M	28	22.5	M14 x 1.5	M8 x 1.25

Rod end nut

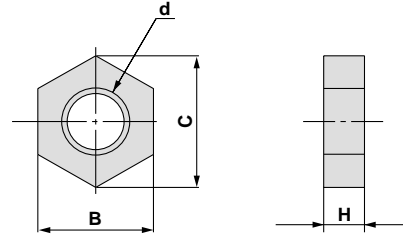

Part no.	Applicable bore size (mm)	B	C	d	H
NTJ-015A	10	8	9.2	M5 x 0.8	4
NT-015A	16	10	11.5	M6 x 1.0	5
NT-02	20	13	15	M8 x 1.25	5
NT-03	25	17	19.6	M10 x 1.25	6
NT-04	28	22	25.4	M14 x 1.5	8

Clevis pin part numbers

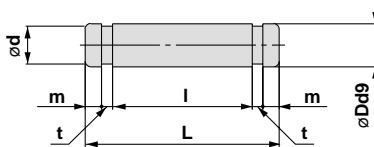

Part no.	Applicable bore size (mm)	Dd9	L	d	l	m	t	Applicable snap ring
IY-J015	10	5 ^{-0.030} _{-0.040}	16.6	4.8	12.2	1.5	0.7	C type 5 for shaft
IY-G02	16	8 ^{-0.040} _{-0.076}	21	7.6	16.2	1.5	0.9	C type 8 for shaft
IY-G03	20	10 ^{-0.040} _{-0.076}	25.6	9.6	20.2	1.55	1.15	C type 10 for shaft
IY-G04	25, 28	10 ^{-0.040} _{-0.076}	41.6	9.6	36.2	1.55	1.15	C type 10 for shaft

Metal Seal

Lateral Load Resisting Compact Low Friction Cylinder

Series MQM

ø6, ø10, ø16, ø20, ø25

How to Order

MQML B 10 15 D

Lateral load resisting low friction specification

Type

L	Lateral load resisting type (built-in ball bushing)
----------	---

Mounting

B	Standard type
L	Foot type
F	Front flange type
G	Rear flange type (except ø6)
C <small>Note</small>	Single clevis type (non-integrated type)
D	Double clevis type

Note 1) Bore size: 20, 25mm only

* Mounting brackets are included when shipped, but are not assembled. (Except clevis types.)

Note 2) ø6, ø10, ø16 Integrated type
ø20, ø25 Non-integrated type

Action

D	Double acting
----------	---------------

Cylinder stroke

Bore size (mm)	Standard stroke (mm)
6	15, 30, 45, 60
10	15, 30, 45, 60, 75, 100
16	15, 30, 45, 60, 75, 100
20	15, 30, 45, 60, 75, 100
25	15, 30, 45, 60, 75, 100

* Strokes are available in 1mm increments by installing spacers in standard stroke cylinders.

Function

Nil	Standard type
H <small>Note</small>	High speed/high frequency type (without fixed orifice)

Note) Except 6mm bore size.

Bore size

6	6mm
10	10mm
16	16mm
20	20mm
25	25mm

* Series MQM is not auto switch capable.

Mounting Bracket Types and Accessories

Mounting bracket		B: Standard	L: Foot	F: Front flange	G: Rear flange	C: Single clevis	D: Double clevis	Note
Standard	Mounting nut <small>Note 1)</small>	● (1 pc.)	● (2 pcs.)	● (1 pc.)	● (1 pc.)	—	— <small>Note 2)</small>	
	Rod end nut	●	●	●	●	●	●	
	Clevis pin	—	—	—	—	—	●	
Option	T-bracket	—	—	—	—	—	●	With pin

Note 1) Mounting nut is not included with integral clevis, single clevis and double clevis types.

Note 2) Pin and snap ring are packed with double clevis type.

Mounting Bracket Part Numbers

Bore size (mm)	Foot <small>Note 1)</small>	Flange	Single clevis	Double clevis (with pin) <small>Note 2)</small>	T-bracket <small>Note 3)</small>
6	CJK-L016B	CJK-F016B	—	—	CJ-T010B
10			—	—	
16	CLJ-L016B	CLJ-F016B	—	—	CJ-T016B
20	CM-L020B	CM-F020B	CM-C020B	CM-D020B	—
25	CM-L032B	CM-F032B	CM-C032B	CM-D032B	—

Note 1) Two foot brackets and one mounting nut are included.

Note 2) Clevis pin and snap ring are included in package.

Note 3) The T-bracket is applicable to the double clevis type (D).

Specifications



Bore size (mm)		6	10	16	20	25
Seal construction		Metal seal				
Action		Double acting single rod				
Fluid		Air				
Proof pressure		1.05MPa				
Maximum operating pressure		0.7MPa				
Minimum operating pressure <small>Note 1)</small>	Standard type	0.02MPa	0.005MPa			
	H (High speed/High frequency type)	—	0.01MPa			
Ambient and fluid temperature		-10 to 80°C				
Cushion		Rubber bumper (standard)				
Lubrication <small>Note 2)</small>		Not required (non-lube)				
Rod end thread tolerance		JIS class 2				
Stroke length tolerance		$\begin{matrix} +1.0 \\ 0 \end{matrix}$				
Piston speed <small>Note 3)</small>	Standard type	0.5 to 1000mm/s (Refer to page 23.)				
	H (High speed/High frequency type)	—	5 to 3000mm/s (Refer to page 23.)			
Total allowable leakage	Supply pressure 0.1MPa	150cm ³ /min or less	250cm ³ /min or less	300cm ³ /min or less		
	Supply pressure 0.3MPa	800cm ³ /min or less	1000cm ³ /min or less	1200cm ³ /min or less		
	Supply pressure 0.5MPa	1500cm ³ /min or less	2500cm ³ /min or less	3000cm ³ /min or less		

Symbol

Double acting: Single rod

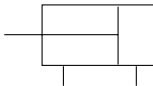

Note 1) Use clean, dry air with no freezing.

Note 2) Refer to precautions on page 21 regarding lubrication.

Note 3) Control low speed actuation with differential pressure and a speed controller, etc.
(Refer to recommended circuit examples for further details.)

Weights/Standard Type, High Speed/High Frequency Type

Unit: g

Bore size (mm)	Cylinder stroke (mm)					
	15	30	45	60	75	100
6	52.5	60.7	68.9	77.1	—	—
10	92.4	102.7	113.0	123.3	133.6	143.9
16	152.4	175.2	198.0	220.8	243.6	266.4
20	349.8	392.6	435.4	478.2	521.0	563.8
25	460.8	510.0	559.2	608.4	657.6	706.8

Theoretical Output



Unit: N

Bore size (mm)	Rod size (mm)	Direction	Piston area (mm ²)	Operating pressure (MPa)						
				0.1	0.2	0.3	0.4	0.5	0.6	0.7
6	4	IN	15.7	1.6	3.2	4.7	6.3	7.9	9.4	11.0
		OUT	28.3	2.8	5.7	8.5	11.3	14.2	17.0	19.8
10	4	IN	66.0	6.6	13.2	19.8	26.4	33.0	39.6	46.2
		OUT	78.5	7.9	15.7	23.6	31.4	39.3	47.1	55.0
16	5	IN	181.4	18.1	36.3	54.4	72.6	90.7	108.8	127.0
		OUT	201.1	20.1	40.2	60.3	80.4	100.6	120.7	140.8
20	8	IN	263.9	26.4	52.8	79.2	105.6	132.0	158.3	184.7
		OUT	314.2	31.4	62.8	94.3	125.7	157.1	188.5	219.9
25	10	IN	412.3	41.2	82.5	123.7	164.9	206.2	247.4	288.6
		OUT	490.9	49.1	98.2	147.3	196.4	245.5	294.5	343.6

Series MQM

Construction

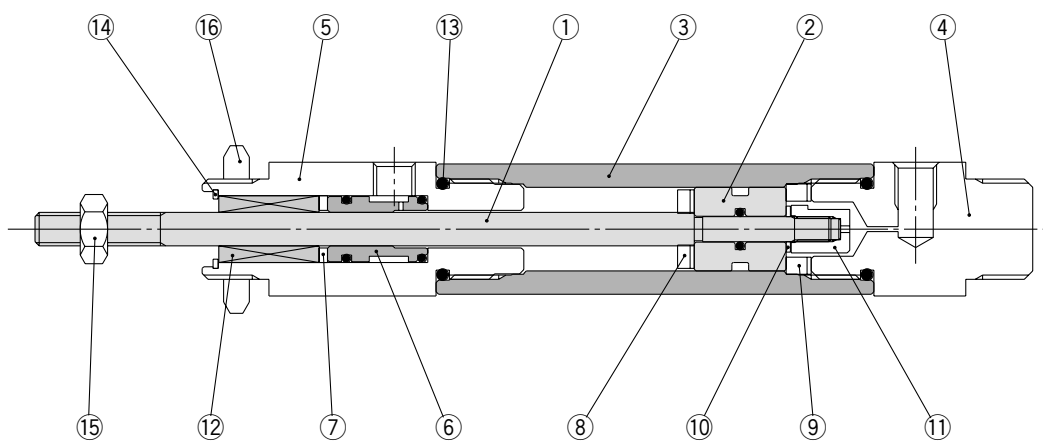

Parts list

No.	Description	Material	Note
1	Rod	Carbon steel	Hard chrome plated
2	Piston	Special stainless steel	
3	Tube	Special stainless steel	
4	Head cover	Aluminum alloy	Hard anodized
5	Rod cover	Aluminum alloy	Hard anodized
6	Sleeve	Special stainless steel	
7	Seat	NBR	
8	Bumper A	Polyurethane	
9	Bumper B	Polyurethane	
10	Bumper C	Polyurethane	
11	Nut	Aluminum alloy	
12	Ball bushing		
13	O-ring	NBR	
14	Snap ring	Carbon tool steel	Nickel plated
15	Rod end nut	Steel	Nickel plated
16	Mounting nut	Steel	

Dimensions

Standard type/MQMLB

ø6

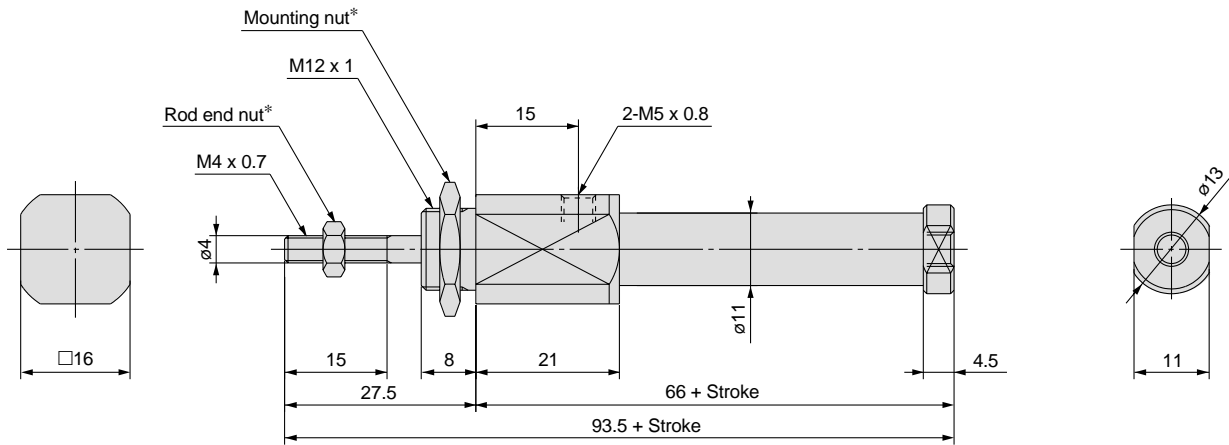

ø10, ø16, ø20, ø25

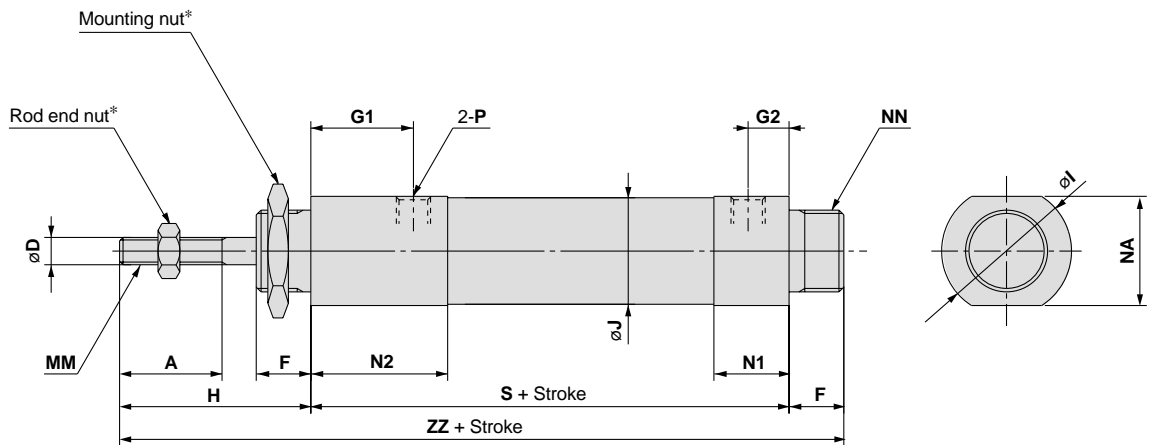

(mm)

Bore size (mm)	A	D	F	G1	G2	H	I	J	MM	N1	N2	NA	NN	P	S	ZZ
10	15	4	8	15	6	28	18.5	16	M4 x 0.7	11	20	16	M12 x 1	M5 x 0.8	65	101
16	15	5	10	15	6	30	22	22	M5 x 0.8	12	21	19.5	M14 x 1	M5 x 0.8	74	114
20	18	8	13	25	8.5	40.5	31.5	28.5	M8 x 1.25	20.5	33	29	M20 x 1.5	Rc 1/8	97.5	151
25	18	10	13	30	8.5	44.5	34.5	32	M10 x 1.25	20.5	38	32	M26 x 1.5	Rc 1/8	102.5	160

* Refer to page 18 for details regarding the rod end nut and mounting nut.

Series MQM

Dimensions

Refer to the standard type on page 14 for other dimensions.

Foot type/MQMLL

ø6

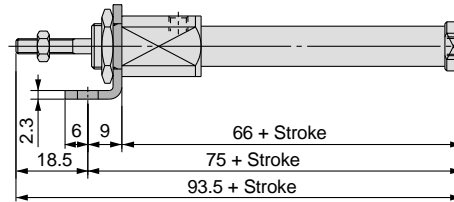
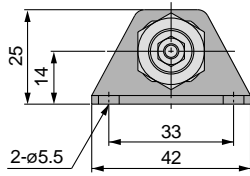

ø10, ø16, ø20, ø25

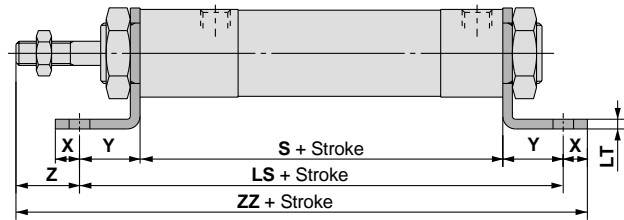
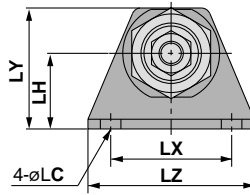

(mm)

Bore size (mm)	LC	LH	LS	LT	LX	LY	LZ	S	X	Y	Z	ZZ
10	5.5	14	83	2.3	33	25	42	65	6	9	19	108
16	5.5	18	92	2.3	42	30	54	74	6	9	21	119
20	6.8	25	137.5	3.2	40	40	55	97.5	8	20	20.5	166
25	6.8	28	142.5	3.2	40	47	55	102.5	8	20	24.5	175

Front flange type/MQMLF

ø6

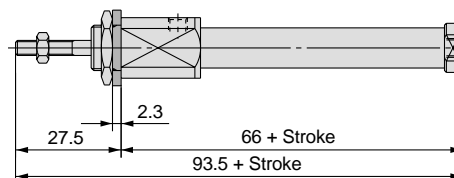
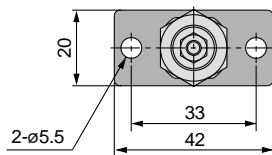

ø10, ø16, ø20, ø25

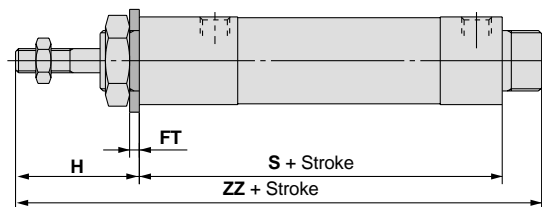
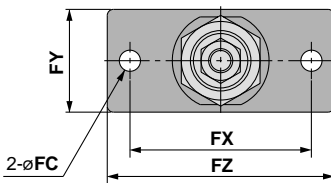

(mm)

Bore size (mm)	FC	FT	FX	FY	FZ	H	S	ZZ
10	5.5	2.3	33	20	42	28	65	101
16	5.5	2.3	42	24	54	30	74	114
20	7	4	60	34	75	40.5	97.5	151
25	7	4	60	40	75	44.5	102.5	160

(Refer to the standard type on page 14 for other dimensions.)

Dimensions

**Rear flange type/MQMLG (except $\phi 6$)
 $\phi 10, \phi 16, \phi 20, \phi 25$**

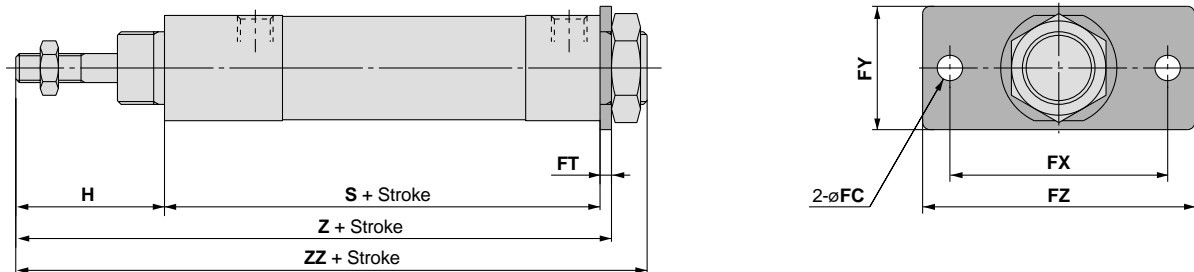

(mm)

Bore size (mm)	FC	FT	FX	FY	FZ	H	S	Z	ZZ
10	5.5	2.3	33	20	42	28	65	95.3	101
16	5.5	2.3	42	24	54	30	74	106.3	114
20	7	4	60	34	75	40.5	97.5	142	151
25	7	4	60	40	75	44.5	102.5	151	160

**Single clevis type/MQMLC ($\phi 20$ and $\phi 25$ only)
 $\phi 20, \phi 25$ (non-integrated type)**

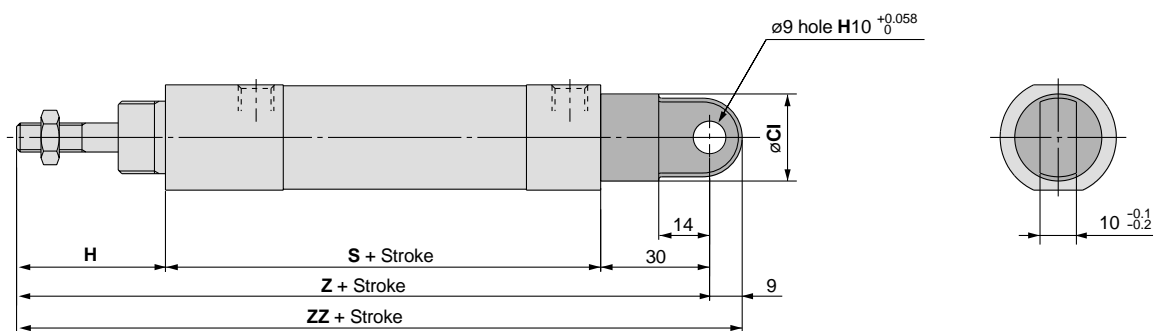

(mm)

Bore size (mm)	CI	H	S	Z	ZZ
20	24	40.5	97.5	168	177
25	30	44.5	102.5	177	186

Series MQM

Dimensions

Refer to the standard type on page 14 for other dimensions.

Double clevis type/MQMLD $\varnothing 6, \varnothing 10, \varnothing 16$ (integrated type)

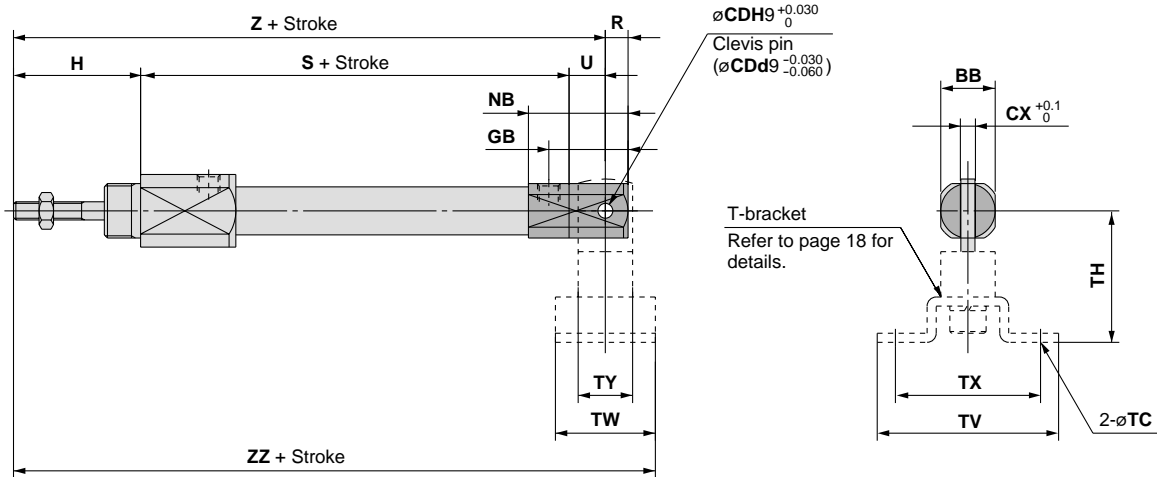

(mm)

Bore size (mm)	BB	CD	CX	GB	H	NB	R	S	U	Z	ZZ
6	12	3.3	3.3	17.5	27.5	22	5	70.5	8	106	117
10	12	3.3	3.3	19	28	24	5	65	8	101	112
16	18	5	6.6	24	30	30	8	74	10	114	128

T-bracket related dimensions (Note)

Part no.	Applicable bore size (mm)	TC	TH	TV	TW	TX	TY
CJ-T010B	6, 10	4.5	29	40	22	32	12
CJ-T016B	16	5.5	35	48	28	38	16

Note) Refer to page 18 for details.

$\varnothing 20, \varnothing 25$ (non-integrated type)

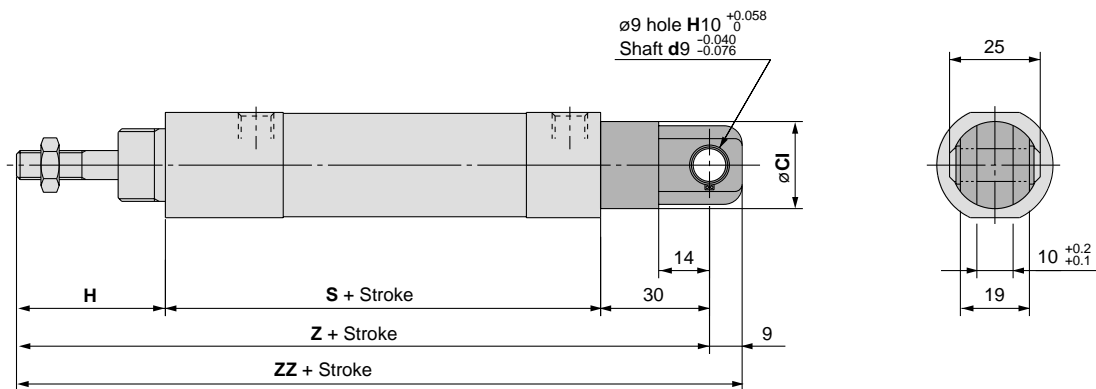

(mm)

Bore size (mm)	CI	H	S	Z	ZZ
20	24	40.5	97.5	168	177
25	30	44.5	102.5	177	186

Accessory Dimensions

Mounting nut

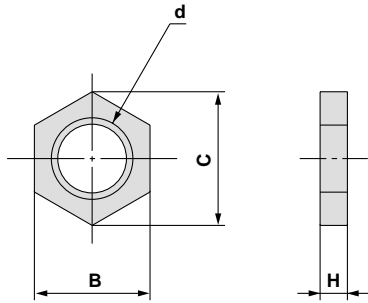

Rod end nut

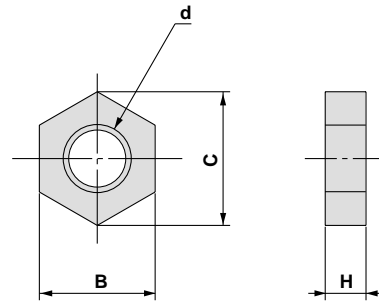

Material: Carbon steel

Part no.	Applicable bore size (mm)	B	C	d	H
SNKJ-016B	6, 10	17	19.6	M12 x 1	4
SNLJ-016B	16	19	21.9	M14 x 1	5
SN-020B	20	26	30	M20 x 1.5	8
SN-032B	25	32	37	M26 x 1.5	8

Material: Carbon steel

Part no.	Applicable bore size (mm)	B	C	D	H
NTJ-010A	6, 10	7	8.1	M4 x 0.7	3.2
NTJ-015A	16	8	9.2	M5 x 0.8	4
NT-02	20	13	15	M8 x 1.25	5
NT-03	25	17	19.6	M10 x 1.25	6

T-bracket

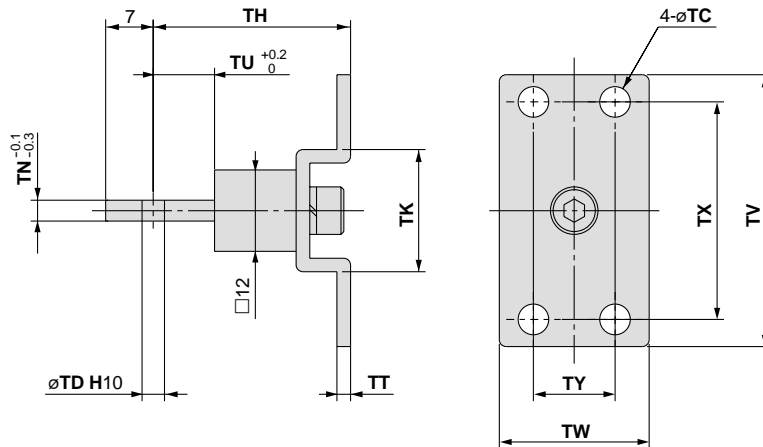

Part no.	Applicable bore size (mm)	TC	TD	TH	TK	TN	TT	TU	TV	TW	TX	TY
CJ-010B	6, 10	4.5	3.3	29	18	3.1	2	9	40	22	32	12
CJ-016B	16	5.5	5	35	20	6.4	2.3	14	48	28	38	16

Clevis pin

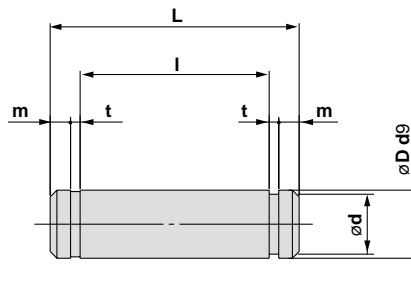

Material: Stainless steel

Part no.	Applicable bore size (mm)	d	D	l	L	m	t
CD-J010	6, 10	3	3.3	12.2	15.2	1.2	0.3
CD-Z015	16	4.8	5	18.3	22.7	1.5	0.7
CDP-1	20, 25	8.6	9	19.2	25	1.75	1.15





Series *MQQ/MQM*

Safety Instructions

These safety instructions are intended to prevent a hazardous situation and/or equipment damage. These instructions indicate the level of potential hazard by a label of "**Caution**", "**Warning**" or "**Danger**". To ensure safety, be sure to observe ISO 4414 Note 1), JIS B 8370 Note 2) and other safety practices.

 **Caution** : Operator error could result in injury or equipment damage.

 **Warning** : Operator error could result in serious injury or loss of life.

 **Danger** : In extreme conditions, there is a possible result of serious injury or loss of life.

Note 1) ISO 4414: Pneumatic fluid power – Recommendations for the application of equipment to transmission and control systems

Note 2) JIS B 8370: General Rules for Pneumatic Equipment

Warning

1. The compatibility of pneumatic equipment is the responsibility of the person who designs the pneumatic system or decides its specifications.

Since the products specified here are used in various operating conditions, their compatibility for the specific pneumatic system must be based on specifications or after analysis and/or tests to meet your specific requirements.

2. Only trained personnel should operate pneumatically operated machinery and equipment.

Compressed air can be dangerous if an operator is unfamiliar with it. Assembly, handling or repair of pneumatic systems should be performed by trained and experienced operators.

3. Do not service machinery/equipment or attempt to remove components until safety is confirmed.

1. Inspection and maintenance of machinery/equipment should only be performed after confirmation of safe locked-out control positions.
2. When equipment is to be removed, confirm the safety process as mentioned above. Cut the supply pressure for this equipment and exhaust all residual compressed air in the system.
3. Before machinery/equipment is restarted, take measures to prevent shooting-out of cylinder piston rod, etc. (Bleed air into the system gradually to create back-pressure.)

4. Contact SMC if the product is to be used in any of the following conditions:

1. Conditions and environments beyond the given specifications, or if product is used outdoors.
2. Installation on equipment in conjunction with atomic energy, railway, air navigation, vehicles, medical equipment, food and beverages, recreation equipment, emergency stop circuits, press applications, or safety equipment.
3. An application which has the possibility of having negative effects on people, property, or animals, requiring special safety analysis.



Series MQQ/MQM Actuator Precautions 1

Be sure to read before handling.

Design

⚠ Warning

1. **There is a danger of sudden action by air cylinders if sliding parts of machinery are twisted and changes in force occur.**

In such cases, human injury may occur; e.g., by catching hands or feet in the machinery, or damage to the machinery itself may occur. Therefore, the machine should be adjusted to operate smoothly and designed to avoid such dangers.

2. **A protective cover is recommended to minimize the risk of human injury.**

If a driven object and moving parts of a cylinder pose a danger of human injury, design the structure to avoid contact with the human body.

3. **Securely tighten all stationary parts and connected parts so that they will not become loose.**

Particularly when a cylinder operates with high frequency or is installed where there is a lot of vibration, ensure that all parts remain secure.

4. **A deceleration circuit or shock absorber, etc., may be required.**

When a driven object is operated at high speed or the load is heavy, a cylinder's cushion will not be sufficient to absorb the shock. Install a deceleration circuit to reduce the speed before cushioning, or install an external shock absorber to relieve the shock. In this case, the rigidity of the machinery should also be examined.

5. **Consider the possibility that operating pressure may drop due to a power outage, etc.**

When a cylinder is used in a clamping mechanism, there is a danger of work pieces dropping if there is a decrease in clamping force due to a drop in circuit pressure caused by a power outage, etc. Therefore, safety equipment should be installed to prevent damage to machinery and human injury. Suspension mechanisms and lifting devices also require consideration for drop prevention.

6. **Consider a possible loss of power source.**

Measures should be taken to protect against human injury and equipment damage in the event that there is a loss of power to equipment controlled by pneumatics, electricity or hydraulics, etc.

7. **Design circuitry to prevent sudden lurching of driven objects.**

When a cylinder is driven by an exhaust center type directional control valve or when starting up after residual pressure is exhausted from the circuit, etc., the piston and its driven object will lurch at high speed if pressure is applied to one side of the cylinder because of the absence of air pressure inside the cylinder. Therefore, equipment should be selected and circuits designed to prevent sudden lurching, because there is a danger of human injury and/or damage to equipment when this occurs.

8. **Consider emergency stops.**

Design so that human injury and/or damage to machinery and equipment will not be caused when machinery is stopped by a safety device under abnormal conditions, such as a power outage or a manual emergency stop.

Design

⚠ Warning

9. **Consider the action when operation is restarted after an emergency stop or abnormal stop.**

Design the machinery so that human injury or equipment damage will not occur upon restart of operation. When the cylinder has to be reset at the starting position, install safe manual control equipment.

Selection

⚠ Warning

1. **Confirm the specifications.**

The products advertised in this catalog are designed according to use in industrial compressed air systems. If the products are used in conditions where pressure, temperature, etc., are out of specification, damage and/or malfunction may be caused. Do not use in these conditions. (Refer to specifications.) Consult SMC if you use a fluid other than compressed air.

2. **Intermediate stops**

When intermediate stopping of the cylinder piston is performed by a 3 position closed center type directional control valve, it is not possible to maintain the stop position for an extended time due to the construction of the metal seal cylinder.

⚠ Caution

1. **Operate the piston within a range such that collision damage will not occur at the stroke end.**
2. **When controlling cylinder output, do not create a restricting circuit by using a speed controller, etc. Pressure inside the cylinder will drop and control will become impossible. Be sure to control actuation through pressure control.**

Mounting

⚠ Caution

1. **Be certain to align the rod axis with the load and direction of movement when connecting.**
When not properly aligned twisting may occur in the rod and tube, and this may cause abrasion or galling on the inside of the tube, and the surface of the bushings and rod, etc.
2. **When an external guide is used, connect the rod end and the load in such a way that there is no interference at any point within the stroke.**
3. **Do not scratch or gouge the cylinder tube or sliding parts of the piston rod by striking or grasping them with other objects.**

Cylinder bores are manufactured to precise tolerances, so that even a slight deformation may cause faulty operation. Moreover, scratches or gouges, etc., in the sliding part of the piston rod may cause malfunction.

4. **Prevent the seizure of rotating parts.**

Prevent the seizure of rotating parts (pins, etc.) by applying grease.



Series MQQ/MQM Actuator Precautions 2

Be sure to read before handling.

Mounting

⚠ Caution

5. Do not use equipment until you verify that it can operate properly.

After mounting, repair or modification, etc., connect the air supply and electric power, and then confirm proper mounting by means of appropriate function and leak inspections.

6. Instruction manual

Mount and operate the product after thoroughly reading the manual and understanding its contents.
Also, keep the manual where it can be referred to as needed.

Piping

⚠ Caution

1. Preparation before piping

Before piping is connected, it should be thoroughly blown out with air (flushing) or washed to remove chips, cutting oil and other debris from inside the piping.

2. Wrapping of sealant tape

When screwing together pipes and fittings, etc., be certain that chips from the pipe threads and sealant material do not get inside the piping.

Also, when sealant tape is used, leave 1.5 to 2 thread ridges exposed at the end of the threads.

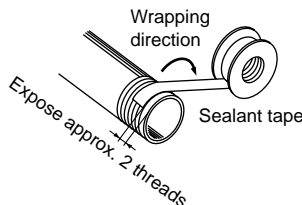

Lubrication

⚠ Caution

1. Lubrication of non-lube type cylinder

Do not apply lubrication when controlling for low speed or controlled output. If lubrication is applied, there may be changes in operating resistance due to factors such as the viscosity and surface tension of the oil. Also, use a metal seal type when using solenoid valves for cylinder actuation. If a rubber seal type is used, there may be an increase in operating resistance due to grease sprayed from the main valve.

Lubrication is also unnecessary for high speed actuation, but in the event that lubrication is applied, use turbine oil class 1 (with no additives) ISO VG32. (Do not use spindle oil or machine oil.)

Air Supply

⚠ Warning

1. Use clean air.

Do not use compressed air containing chemicals, synthetic oils containing organic solvents, salt or corrosive gases, etc., as it can cause damage or malfunction.

Air Supply

⚠ Caution

1. Install air filters.

Install air filters near valves on their upstream side. The filtration degree should be 5 μ m or less. Furthermore, when controlling for low speed or controlled output, use clean air (atmospheric pressure dew point temperature of -10°C). Installation of mist separator series AM (filtration degree 0.3 μ m or less) or series AM + AMD (filtration degree 0.01 μ m or less) is also recommended.

2. Install an after-cooler, air dryer or water separator, etc.

Air that contains excessive drainage can cause malfunction of valves and other pneumatic equipment. To prevent this, install an after-cooler, air dryer or water separator, etc.

3. Use the product within the range of specifications for fluid and ambient temperature.

Take measures to prevent freezing when used at 5 $^{\circ}\text{C}$ or less, since moisture in circuits can freeze and this may cause malfunction.

Refer to the "Air Cleaning Equipment" catalog for details on compressed air quality.

Operating Environment

⚠ Warning

1. Do not use in environments where there is a danger of corrosion.

Refer to the construction drawings regarding cylinder materials.

2. Do not use in dusty locations or where water, oil, etc., will splash on the equipment.

Maintenance

⚠ Warning

1. Perform maintenance according to the procedures indicated in the instruction manual.

If handled improperly, malfunction and damage of machinery or equipment may occur.

2. Removal of equipment and supply/exhaust of compressed air.

When equipment is removed, first check measures to prevent dropping of driven objects and run-away of equipment, etc. Then cut off the supply pressure and electric power, and exhaust all compressed air from the system.

When machinery is restarted, confirm measures to prevent lurching and proceed with caution.

⚠ Caution

1. Drain flushing

Remove drainage from air filters regularly. (Refer to specifications.)



Series MQQ/MQM Specific Product Precautions 1

Be sure to read before handling.

See pages 19 through 21 for safety instructions and actuator precautions.

Operation

Caution

1. When mounting, thoroughly flush out the connector piping and be sure that dirt and chips, etc., do not get inside the cylinder.
2. Install an air filter with a filtration degree of $5\mu\text{m}$ or less on the air supply. Furthermore, when controlling for low speed or controlled output, use clean air (atmospheric pressure dew point temperature of -10°C). Installation of a mist separator (filtration degree $0.3\mu\text{m}$ or less) is also recommended.
3. Use a metal seal type when using solenoid valves for cylinder actuation. If a rubber seal type is used, there may be an increase in operating resistance due to grease sprayed from the main valve.
4. Operate so that the load applied to the piston rod is normally in the axial direction.

In the event that a lateral load is unavoidable, do not exceed the range of the allowable lateral load at the rod end (refer to pages 23 and 24). (Use outside of the operating limits may cause an adverse effect on the life of the unit through problems such as looseness in the guide unit and a loss of precision.)

5. Take care not to scratch or gouge the sliding portion of the rod. This may cause malfunction or shorten the unit's life.
6. When attaching a work piece to the end of the rod, move the rod to the fully retracted position and use the wrench flats at the end of the rod. Fasten the work piece without applying a large amount of torque to the rod.
7. Be certain to connect a load so that the rod axis is aligned with the load and its direction of movement.

Disassembly

Caution

1. The component parts of the metal seal cylinder are manufactured to precision tolerances, and therefore cannot be disassembled.



Series MQQ/MQM Specific Product Precautions 2

Be sure to read before handling.
See pages 19 through 21 for safety instructions and actuator precautions.

Selection

Series MQQ



Operating Speed

Load weight and maximum speed: MQQT/MQQL

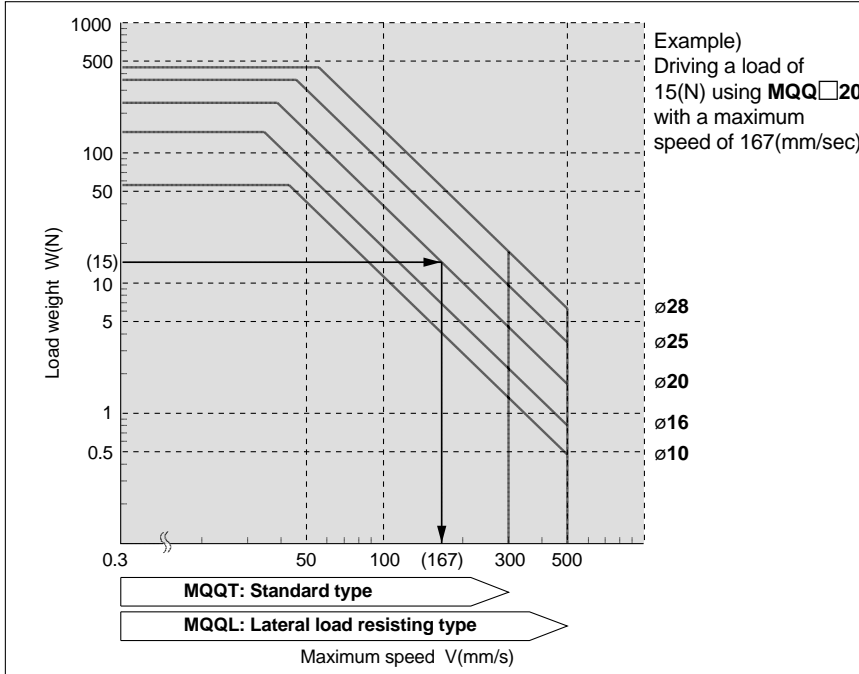

Note 1) When a load is attached to the rod end, adjust the speed so that the maximum speed is no more than that shown in the graph for the corresponding load weight.

Allowable Kinetic Energy

Lateral load resisting type: MQQ□

Bore size (mm)	Allowable kinetic energy (J)
10	0.006
16	0.010
20	0.022
25	0.044
28	0.080

Allowable Lateral Load at Rod End



Standard type: MQQTB

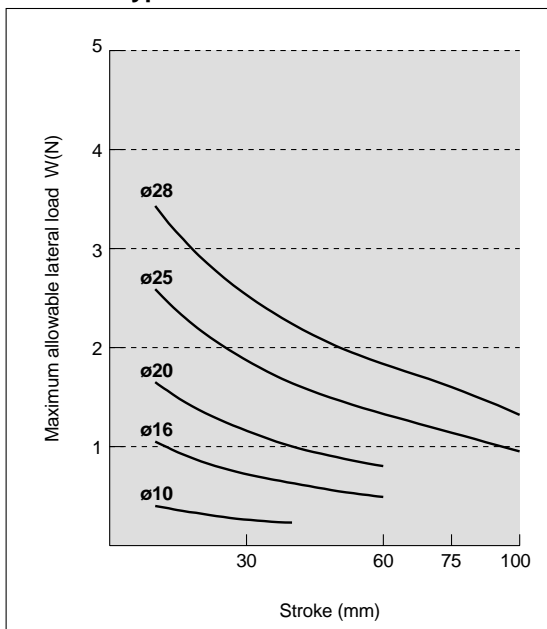

Lateral load resisting type: MQQLB/Built-in ball bushing

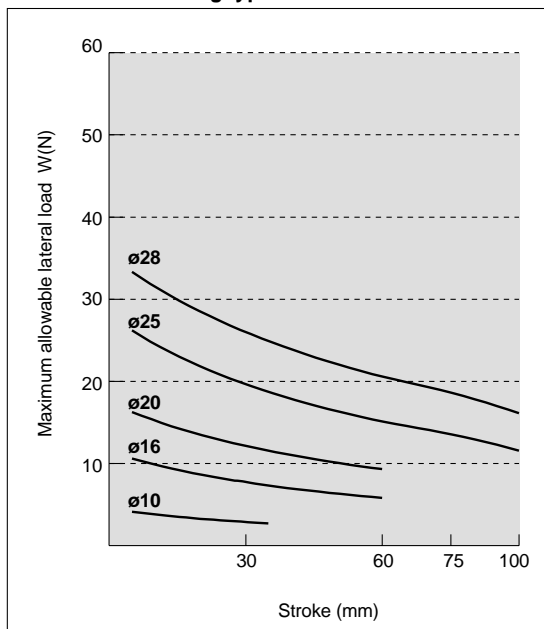

Note 1) The indicated allowable lateral load at the rod end is for rod end female thread.

Note 2) The allowable lateral load varies depending on the size of the load (the distance to the load's center of gravity). Contact SMC for further details.



Series MQQ/MQM Specific Product Precautions 3

Be sure to read before handling.
See pages 19 through 21 for safety instructions and actuator precautions.

Selection

Series MQM



Operating Speed

Load weight and maximum speed

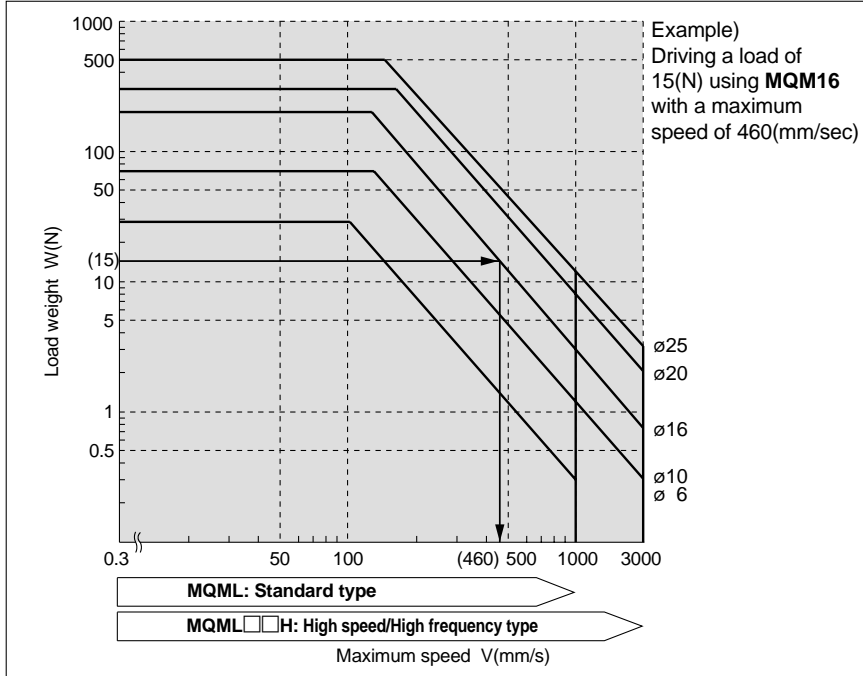

Note 1) When a load is attached to the rod end, adjust the speed so that the maximum speed is no more than that shown in the graph for the corresponding load weight.

Allowable Kinetic Energy

Lateral load resisting type: MQML

Bore size (mm)	Allowable kinetic energy (J)
6	0.015
10	0.059
16	0.161
20	0.386
25	0.597

Allowable Lateral Load at Rod End

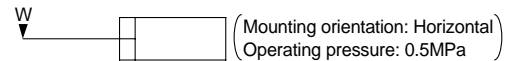

Allowable lateral load at rod end

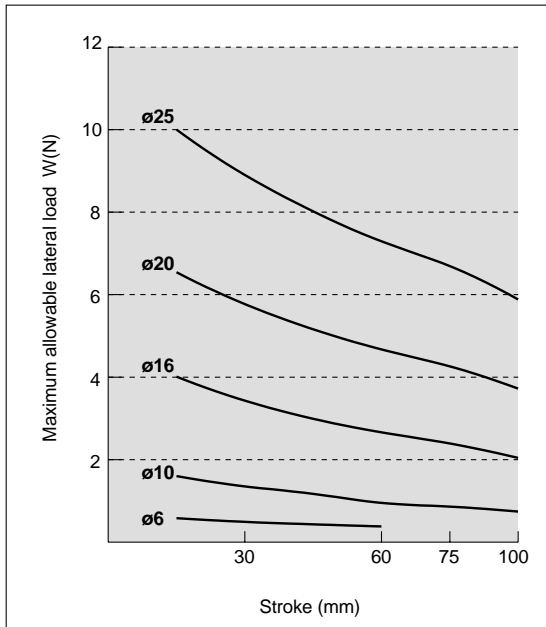

Note 1) The allowable lateral load varies depending on the size of the load (the distance to the load's center of gravity).
Contact SMC for further details.



SMC'S GLOBAL MANUFACTURING, DISTRIBUTION AND SERVICE NETWORK

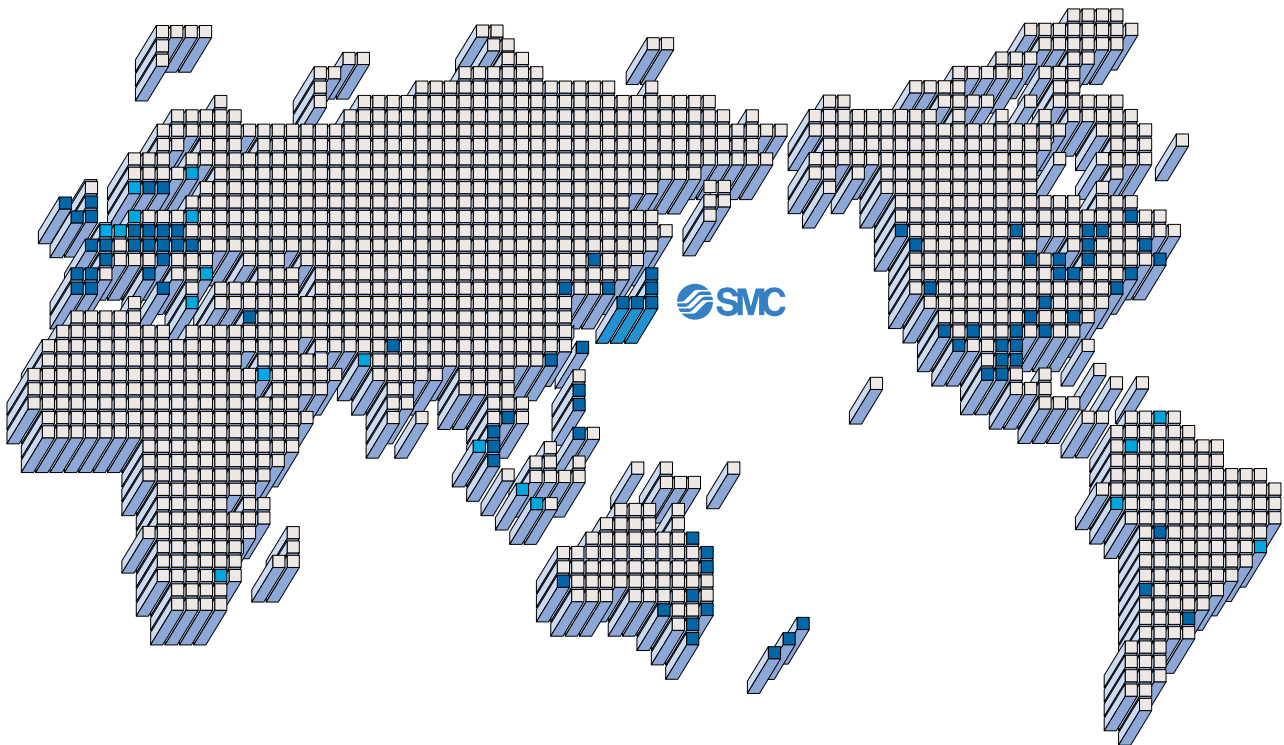

EUROPE

AUSTRIA

SMC Pneumatik GmbH

CZECH

SMC Czech s.r.o.

DENMARK

SMC Pneumatik A/S

FINLAND

SMC Pneumatiikka OY

FRANCE

SMC Pneumatique SA

GERMANY

SMC Pneumatik GmbH

HUNGARY

SMC Hungary Kft.

IRELAND

SMC Pneumatics (Ireland) Ltd.

ITALY

SMC Italia S.p.A.

NETHERLANDS

SMC Pneumatics BV.

NORWAY

SMC Pneumatics Norway A/S

POLAND

SMC Industrial Automation Polska Sp.z.o.o.

ROMANIA

SMC Romania s.r.l.

RUSSIA

SMC Pneumatik LLC.

SLOVAKIA

SMC Slovakia s.r.o.

EUROPE

SLOVENIA

SMC Slovenia d.o.o.

SPAIN/PORTUGAL

SMC España, S.A.

SWEDEN

SMC Pneumatics Sweden AB

SWITZERLAND

SMC Pneumatik AG.

UK

SMC Pneumatics (U.K.) Ltd.

ASIA

CHINA

SMC (China) Co., Ltd.

HONG KONG

SMC Pneumatics (Hong Kong) Ltd.

INDIA

SMC Pneumatics (India) Pvt. Ltd.

MALAYSIA

SMC Pneumatics (S.E.A.) Sdn. Bhd.

PHILIPPINES

SMC Pneumatics (Philippines), Inc.

SINGAPORE

SMC Pneumatics (S.E.A.) Pte. Ltd.

SOUTH KOREA

SMC Pneumatics Korea Co., Ltd.

TAIWAN

SMC Pneumatics (Taiwan) Co., Ltd.

THAILAND

SMC Thailand Ltd.

NORTH AMERICA

CANADA

SMC Pneumatics (Canada) Ltd.

MEXICO

SMC Corporation (Mexico) S.A. de C.V.

USA

SMC Pneumatics, Inc.

SOUTH AMERICA

ARGENTINA

SMC Argentina S.A.

BOLIVIA

SMC Pneumatics Bolivia S.R.L.

BRAZIL

SMC Pneumaticos Do Brazil Ltda.

CHILE

SMC Pneumatics (Chile) S.A.

VENEZUELA

SMC Neumatica Venezuela S.A.

OCEANIA

AUSTRALIA

SMC Pneumatics (Australia) Pty. Ltd.

NEW ZEALAND

SMC Pneumatics (N.Z.) Ltd.

SMC CORPORATION

1-16-4 Shimbashi, Minato-ku, Tokyo 105-0004, JAPAN

Tel: 03-3502-2740 Fax: 03-3508-2480

URL <http://www.smcworld.com>

© 2000 SMC CORPORATION All Rights Reserved

1st printing December, 2000 D-SMC.L.A. P-80 (N)

Specifications are subject to change without prior notice
and any obligation on the part of the manufacturer.

Printed in Japan.